



Crystal Chandelier



INSTALLATION GUIDE

Thank you for choosing Marorient crystal chandelier. Please read this manual carefully for guidance on installation

Items included in the box

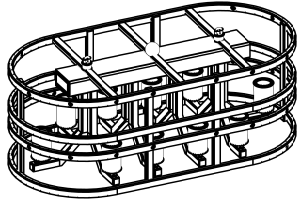

Chandelier

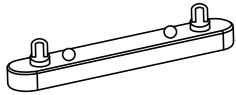

Hanging System

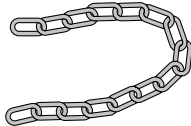

Chain

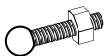

Ball Stud Bolt



Crystals



Protective Cloth

Installation Steps

1 Assemble chain and hanging system

Insert chain into the protective cloth, attach one end of the chain to the chandelier.

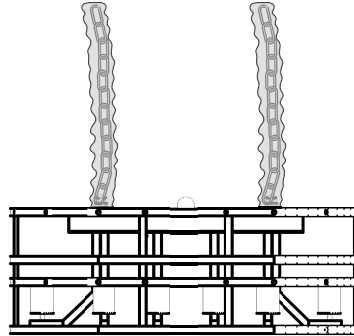

Assemble the hanging system

2 Hang the Chandelier

Mount and screw the ceiling hanging system to ceiling (Screws not included). Attach the chandelier to the installed hanging system using the other end of the chain.

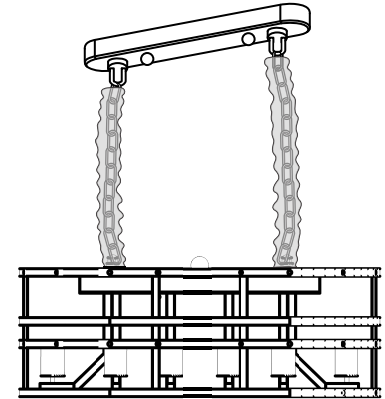

3 Insert Ball Stud Bolt in Crystal

Gently insert the bolt into the crystal's hole. Be very careful not to apply too much pressure or force, as this can crack or break the crystal.

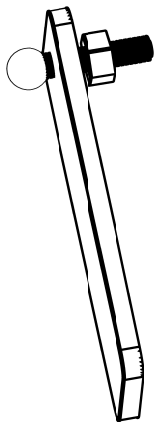

4 Attach all Crystals

After the chandelier is hung, attach the crystals to the chandelier by inserting the bolt with the crystal trough the hole of the base layer. On the other side of the crystal, place the nut. Begin threading the nut onto the bolt by hand.

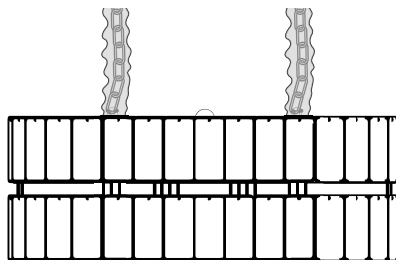

Merci d'avoir choisi le lustre en cristal Marorient.
Veuillez lire attentivement ce manuel pour
vous guider dans l'installation

Éléments contenus dans la boîte

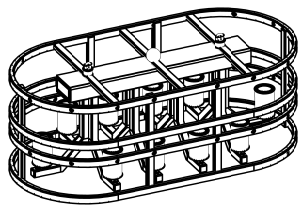

Lustre

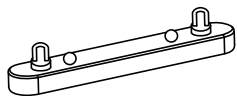

Dispositif d'accrochage

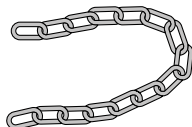

Chaîne

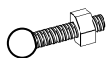

Crochets



Cristaux



Tissu de
protection

Étapes de l'installation

1 Assembler la chaîne et le dispositif d'accrochage

Insérez la chaîne dans le tissu de protection, fixez une extrémité de la chaîne au lustre.

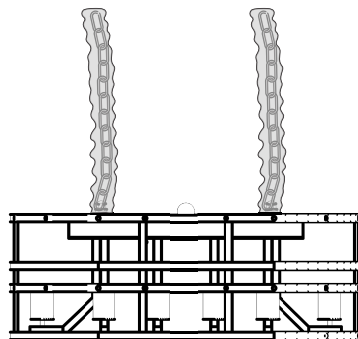

Assembler le dispositif d'accrochage.

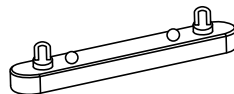

2 Accrocher le lustre

Montez et vissez le dispositif d'accrochage au plafond (Vison incluses). Fixez le lustre au dispositif d'accrochage à l'aide de l'autre extrémité de la chaîne.

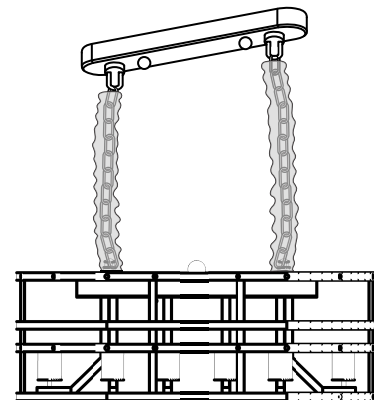

3 Insérer le boulon à bille dans le trou du cristal

Faites très attention de ne pas appliquer trop de pression, car cela pourrait le fissurer ou le casser.

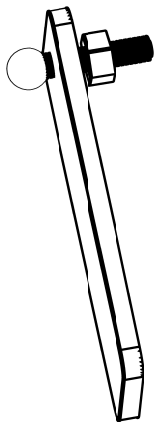

4 Fixez tous les cristaux

Une fois le lustre suspendu, fixez les cristaux au lustre en insérant le boulon à bille avec le cristal à travers le trou dans la base du lustre. De l'autre côté du cristal, placez l'écrou. Commencez à visser l'écrou sur le boulon à la main.

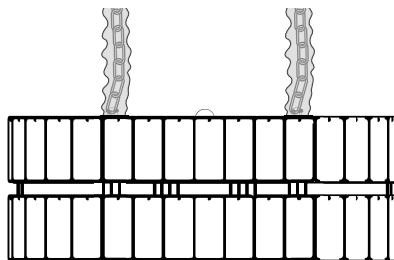

Dank u voor het kiezen van de Marorient kristallen kroonluchter. Gelieve deze handleiding zorgvuldig te lezen om u te begeleiden bij de installatie

Onderdelen in de doos

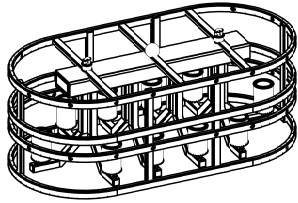

Kroonluchter

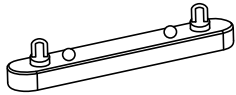

Ophanginrichting

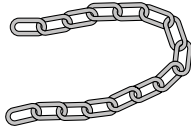

Ketting

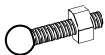

Haken



Kristallen



Beschermende
stof

Installatiestappen

1 Monteer de ketting en het ophangingsysteem

Steek de ketting door de beschermende stof en bevestig een uiteinde van de ketting aan de kristallen kroonluchter.

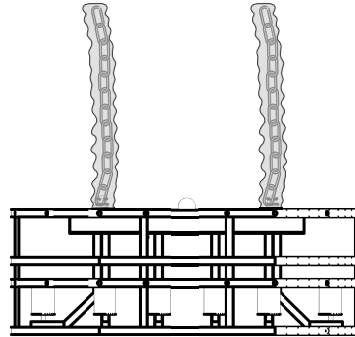

Monteer het ophangingsysteem

2 Hang de kroonluchter op

Bevestig het ophangingsysteem aan het plafond (schroeven niet inbegrepen). Bevestig de kroonluchter aan het ophangings systeem met behulp van het andere uiteinde van de ketting.

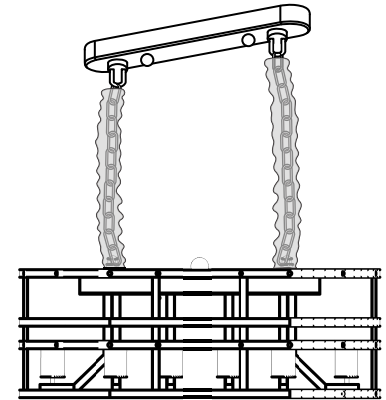

3 Plaats de kogelbout in het gat van de kristal

Wees zeer voorzichtig en oefen niet te veel druk uit, want dit kan het kristal doen barsten of breken.

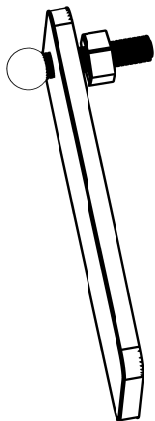

4 Bevestig alle kristallen

Nadat de kroonluchter is opgehangen, bevestig de kristallen aan de kroonluchter door de bout met het kristal door het gat in de basis van de kroonluchter te steken. Aan de andere kant van het kristal, plaats de moer. Draai de moer met de hand op de bout.

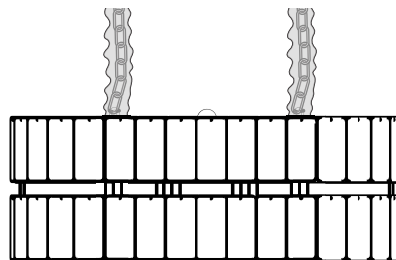

Vielen Dank, dass Sie sich für den Marorient Kristall-Kronleuchter entschieden haben. Bitte lesen Sie diese Anleitung sorgfältig durch, um Sie bei der Installation zu unterstützen.

In der Box enthaltene Artikel:

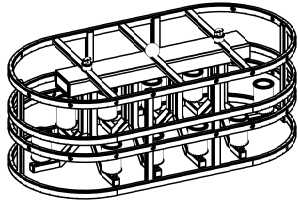

Kronleuchter

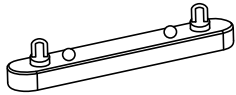

Aufhängen System

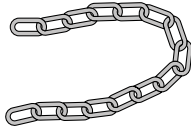

Kette

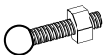

Haken



Kristalle



Schutzstoff

Installationsanleitung:

1 Montieren Sie die Kette und die Aufhängen System

Führen Sie die Kette durch den Schutzstoff und befestigen Sie ein Ende der Kette am Kristall-Lüster.

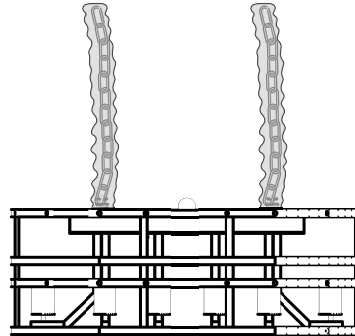

Montieren Sie die Aufhängen System.

2 Hängen Sie den Kronleuchter auf

Befestigen Sie die Aufhängen System an der Decke (Schrauben nicht im Lieferumfang enthalten). Befestigen Sie den Lüster mithilfe des anderen Endes der Kette an der Aufhängen System.

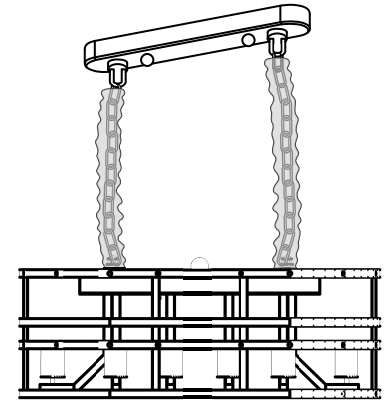

3 Setzen Sie den Kugelbolzen in das Loch des Kristalls

Seien Sie sehr vorsichtig und üben Sie nicht zu viel Druck aus, da dies den Kristall zum Bersten oder Brechen bringen könnte.

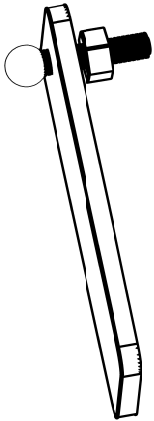

4 Befestigen Sie alle Kristalle

Nachdem der Kronleuchter aufgehängt wurde, befestigen Sie die Kristalle am Kronleuchter, indem Sie den Bolzen mit dem Kristall durch das Loch in der Basis des Kronleuchter stecken. Auf der anderen Seite des Kristalls platzieren Sie die Mutter. Drehen Sie die Mutter von Hand auf den Bolzen.

