



Crystal Chandelier



INSTALLATION GUIDE

Thank you for choosing Marorient crystal chandelier. Please read this manual carefully for guidance on installation

Items included in the box

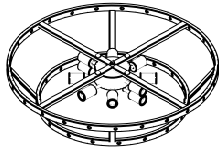

Chandelier

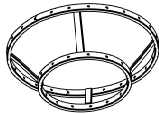

Layer Base for Crystal



Long Bars with Screws

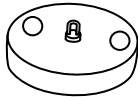

Hanging System

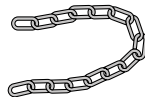

Chain



Hooks



Crystals



Protective Cloth

Installation Steps

1 Attach Layers Base

Mount and screw the layer base for crystals on the chandelier using the long bars and screw included in the box.

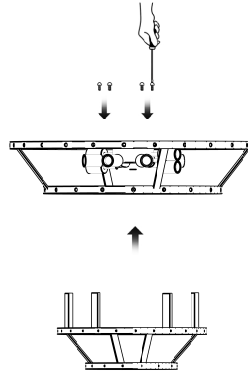

Tighten all screws properly to ensure Firmness.

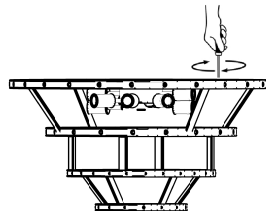

2 Assemble chain and hanging system

Insert chain into the protective cloth, attach one end of the chain to the chandelier.

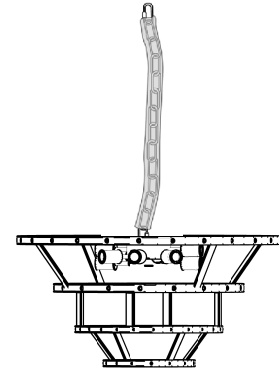

Assemble the hanging system

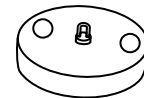

3 Hang the Chandelier

Mount and screw the ceiling hanging system to ceiling (Screws not included). Attach the chandelier to the installed hanging system using the other end of the chain.

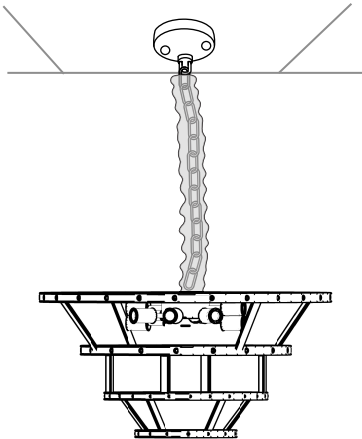

4 Attach all Crystals

After the chandelier is hung, attach the crystals to the chandelier. This should be done by inserting a hook into the hole on each crystal, followed by hanging the crystal on the base layers on the chandelier.

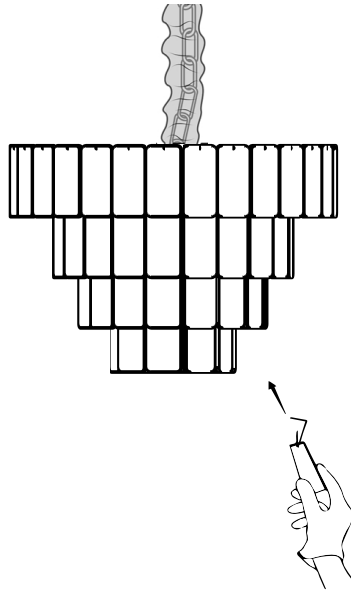

Merci d'avoir choisi le lustre en cristal Marorient. Veuillez lire attentivement ce manuel pour vous guider dans l'installation

Éléments contenus dans la boîte

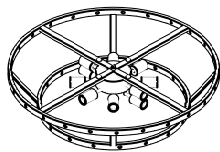

Lustre

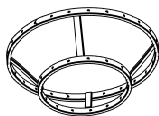

Support à 2 couches



Longues barres
avec vis

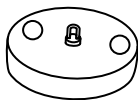

Dispositif
d'accrochage



Chaîne



Crochets



Cristaux



Tissu de
protection

Étapes de l'installation

1 Fixez le support à 2 couches

Montez et vissez le support à 2 couches sur le lustre à l'aide des longues barres et les vis contenus dans la boîte.

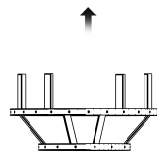
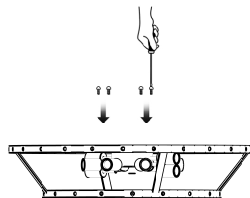

Serrez correctement toutes les vis pour assurer la fermeté.

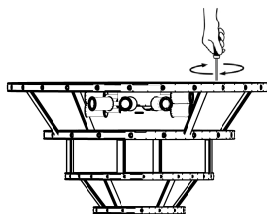

2 Assemblez la chaîne et le dispositif d'accrochage

Insérez la chaîne dans le tissu de protection, fixez une extrémité de la chaîne au lustre.

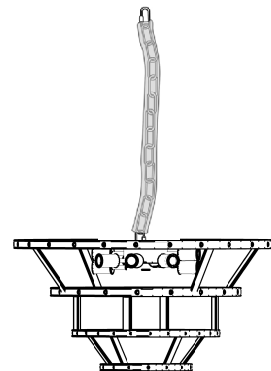

Assembler le dispositif d'accrochage.

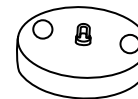

3 Accrocher le lustre

Montez et vissez le dispositif d'accrochage au plafond (Vis non incluses). Fixez le lustre au dispositif d'accrochage à l'aide de l'autre extrémité de la chaîne.

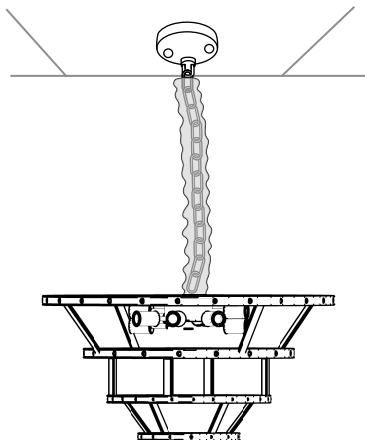

4 Fixez tous les cristaux

Une fois que le lustre est suspendu, fixez les cristaux au lustre. Cela doit être fait en insérant un crochet dans le trou de chaque, puis fixez le cristal sur la base du lustre.

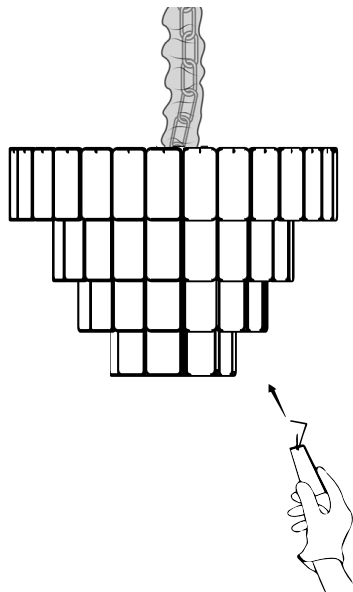

Dank u voor het kiezen van de Marorient kristallen kroonluchter. Gelieve deze handleiding zorgvuldig te lezen om u te begeleiden bij de installatie

Onderdelen in de doos

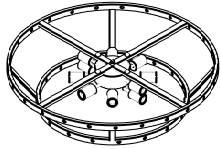

Kroonluchter

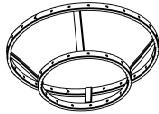

Tweelaagse basis



Lange staven met schroeven

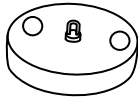

Ophangings systeem

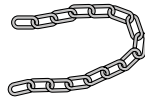

Ketting



Haken



Kristallen



Beschermende stof

Installatiestappen

1 Bevestig de tweelaagse basis

Monteer en schroef de tweelaagse basis aan de kroonluchter met behulp van de lange staven en schroeven die in de doos zijn inbegrepen.

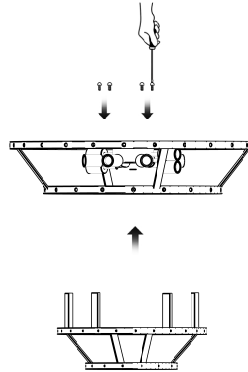

Serrez correctement toutes les vis pour assurer la fermeté.

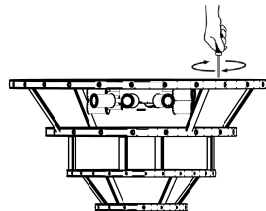

2 Monteer de ketting en het ophangings systeem

Steek de ketting door de beschermende stof en bevestig een uiteinde van de ketting aan de kristallen kroonluchter.

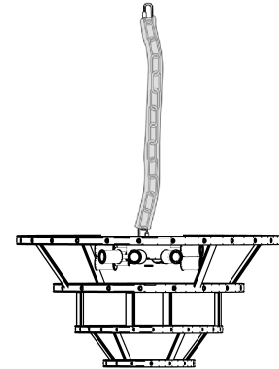

Monteer het ophangingsysteem

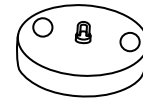

3 Hang de kroonluchter op

Bevestig het ophangings systeem aan het plafond (schroeven niet inbegrepen). Bevestig de kroonluchter aan het ophangings systeem met behulp van het andere uiteinde van de ketting

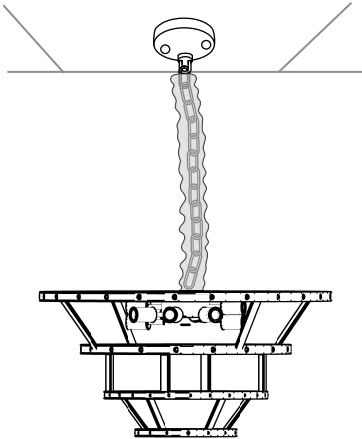

4 Bevestig alle kristallen

Nadat de kroonluchter is opgehangen, bevestig de kristallen aan de kroonluchter. Dit moet worden gedaan door een haak in het gat van elke kristal te steken. Vervolgens hangt u de kristallen aan de basis van de kroonluchter.

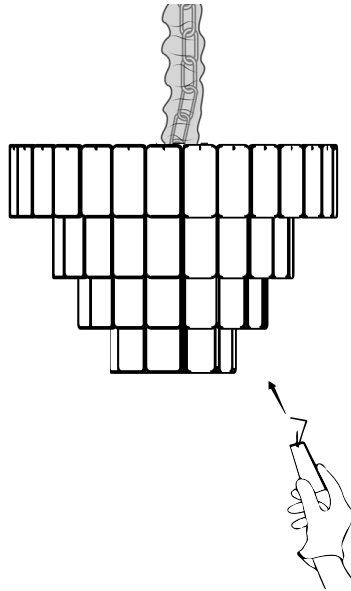

Vielen Dank, dass Sie sich für den Marorient
Kristall-Kronleuchter entschieden haben.
Bitte lesen Sie diese Anleitung sorgfältig
durch, um Sie bei der Installation zu
unterstützen.

In der Box enthaltene Artikel:

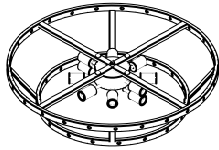

Kronleuchter

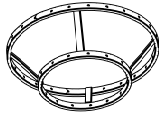

Lagen-Basis für Kristall



Lange Stäbe mit
Schraube

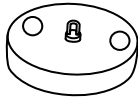

Aufhängen
System

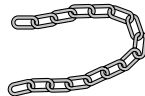

Kette



Haken



Kristalle



Schutzstoff

Installationsanleitung:

1 2-Lagen-Basis anbringen

Montieren und schrauben Sie den 2-lagigen Sockel für die Kristalle mit den langen Stangen und der Schraube, die in der Verpackung enthalten sind, auf den Kronleuchter.

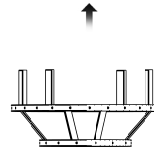
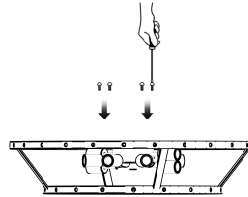

**Serrez correctement toutes les vis
pour assurer la fermeté.**

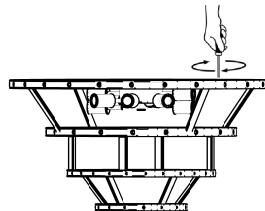

2 Montieren Sie die Kette und die Aufhängen System

Führen Sie die Kette durch den Schutzstoff und
befestigen Sie ein Ende der Kette am
Kristall-Lüster.

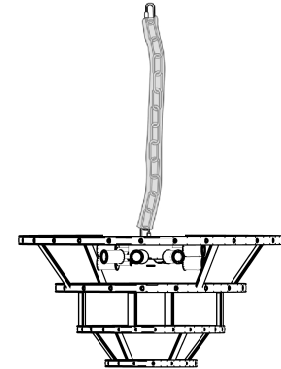

Montieren Sie die Aufhängen System.



3 Hängen Sie den Kronleuchter auf

Befestigen Sie die Aufhängen System an der Decke (Schrauben nicht im Lieferumfang enthalten). Befestigen Sie den Lüster mithilfe des anderen Endes der Kette an der Aufhängen System.

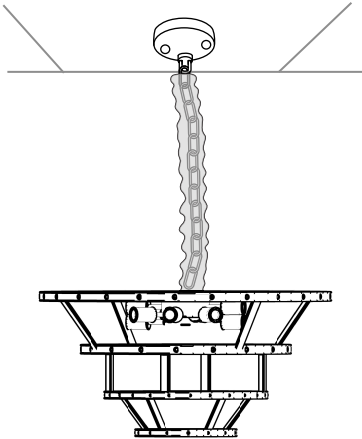

4 Befestigen Sie alle Kristalle

Nachdem der Kronleuchter aufgehängt ist, befestigen Sie die Kristalle am Kronleuchter. Stecken Sie dazu einen Haken ins Loch jedes Kristalls und hängen Sie den Kristall anschließend an die Basisschichten des Leuchters.

